

COMPACT COMPACT COMPACT
COMPACT COMPACT COMPACT
COMPACT COMPACT COMPACT
COMPACT COMPACT COMPACT

Easy working

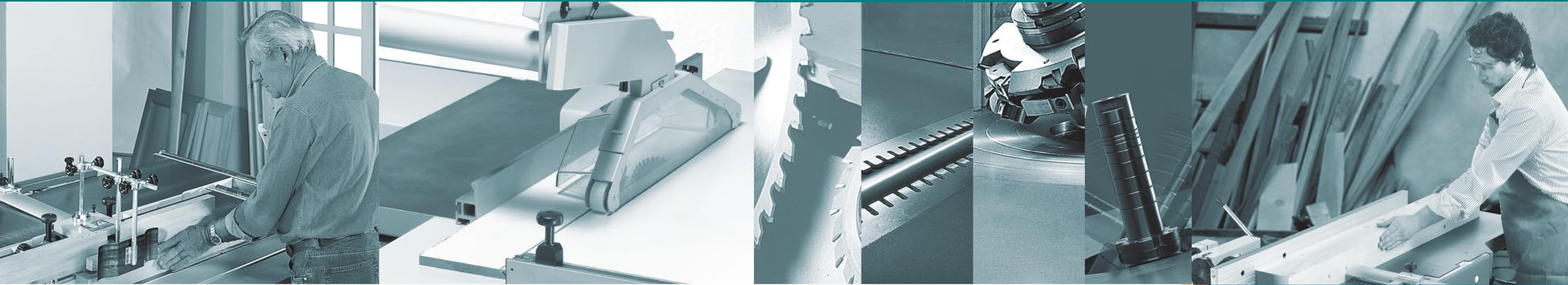

COMPACT

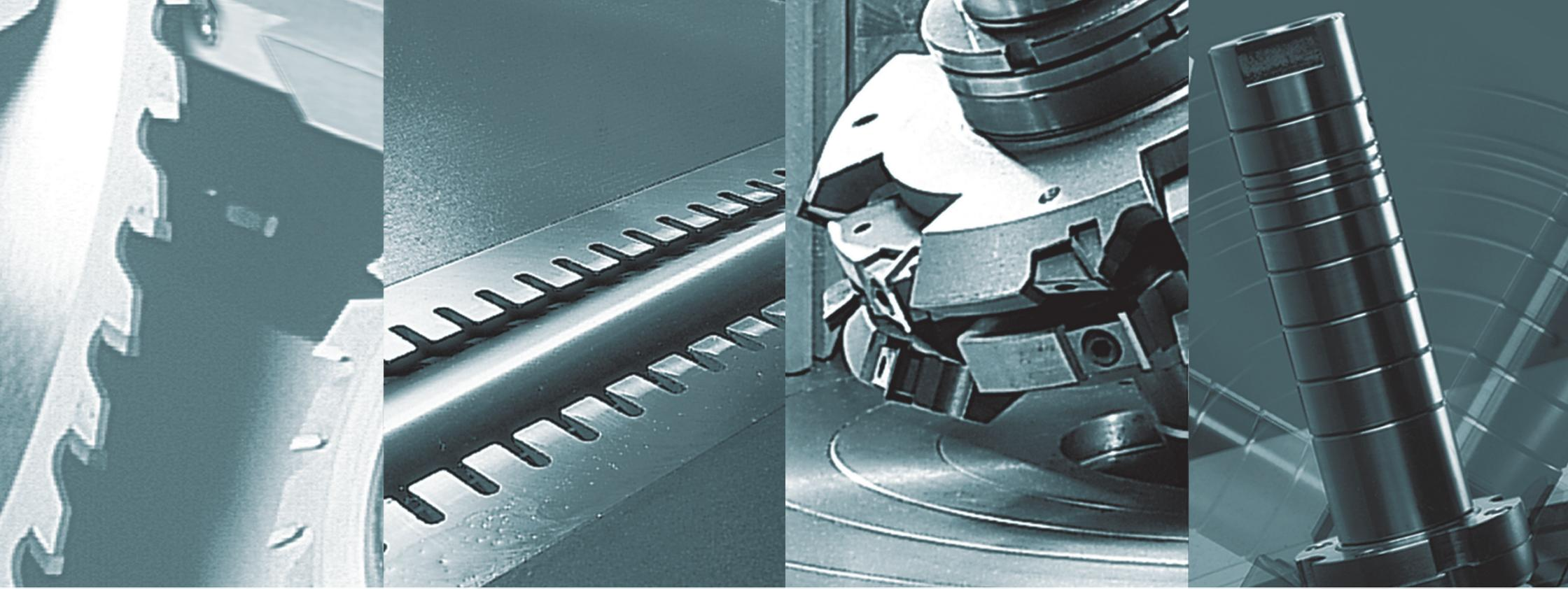

FS 41 PLUS

FILO SPESSORE
DEGAUCHISSEUSE - RABOTEUSE
CAPILLADORA - REGUESADORA

6



PS 43/53/63

FILO SPESSORE
RABOTEUSES / REGUESADORAS

8



PF 31/41/53

PIALLE A FILO
DEGAUCHISSEUSES / CEPILADORAS

9



SC 30 A

SQUADRATRICE CON LAMA INCLINABILE
SCIE À FORMAT À LAME INCLINABLE /
ESCUADRADORA A DISCO INCLINABLE

10



C 30

SQUADRATRICE CON LAMA INCLINABILE
SCIE À FORMAT À LAME INCLINABLE /
ESCUADRADORA A DISCO INCLINABLE

11



C 45

SQUADRATRICE CON LAMA INCLINABILE
SCIE À FORMAT À LAME INCLINABLE /
ESCUADRADORA A DISCO INCLINABLE

12



Easy working

COMPACT



T 22

TOUPIE
TOUPIES - TUPIS

14



T 45 S

TOUPIE CON ALBERO INCLINABILE
TOUPIE AVEC ARBRE INCLINABLE
TUPI CON EJE INCLINABLE

16



SN 32/40/50

SEGHE A NASTRO
SIERRAS A RUBAN / SIERRAS DE CINTA

17



L 25/L 30

LEVIGATRICI A NASTRO
PONEUSE A BANDE
LIJADORA DE BANDA

18



GA - GM

AVANZAMENTI AUTOMATICI
ENTRAÏNEMENTS AUTOMATIQUES
ALIMENTADORES AUTOMATICOS

19



G/A1 - G/A2

ASPIRATORI
ASPIRATEURS / ASPIRADORES

20



GB MANUALE

PLAQUEUSE DE CHANTS MANUELLE
CHAPEADORA MANUAL

21

Un servizio che conta e su cui contare

L'efficienza è un punto fermo della Griggio. Garantita durante l'intero processo che parte dalla progettazione e arriva fino all'assistenza, permette di offrire al cliente, in ogni singola fase, la certezza di un servizio professionale e puntuale. E, soprattutto, di un servizio su cui poter sempre contare.

La messa a funzione di questo meccanismo perfetto è uno dei punti di forza dell'azienda ed è stato possibile crearlo grazie ad un efficiente sistema di programmazione, studiato e perfezionato negli anni, che permette di consegnare i prodotti ai clienti sempre nei tempi prefissati.



Ricambi: un servizio su cui contare

Pièces détachées: un service sur lequel compter
Repuestos: un servicio el que se puede contar



Un trasporto veloce

Transport rapide
Transporte rápido



Il prodotto arriva puntuale

Un produit livré d'une façon ponctuelle
El producto llega puntual

Un service qui compte et sur lequel compter

L'efficacité est un point fixe de la maison Griggio. Garantir un processus total du départ du projet jusqu'à l'assistance, permettant d'offrir au client, à chaque étape, la certitude d'un service professionnel et ponctuel. Et, surtout d'un service sur lequel pouvoir toujours compter.

La mise en service de ce mécanisme parfait est un des points de force de la maison: il a été possible de l'obtenir grâce à un système efficace de programmation étudié et perfectionné au cours des années pour permettre de distribuer les produits aux clients dans les délais fixés.

Un servicio que cuenta en el que se puede contar

La eficacia es el punto más importante de Griggio. Garantizada durante todo el proceso que empieza desde el proyecto y termina con la asistencia, permite de ofrecer al cliente, en cada singular fase, la certeza de un servicio profesional y puntual. Y, en particular, de un servicio en que se puede contar siempre.

La puesta en marcha de este mecanismo perfecto es uno de los puntos de fuerza de la empresa y ha sido posible realizarlo gracias a un sistema eficaz de programación, estudiado y perfeccionado en los años, que permite entregar los productos a los clientes en el plazo pactado.



Griggio On-Line, in tempo reale

On line per un servizio completo e immediatamente accessibile.

Il sito della Griggio è una porta sempre aperta che permette al cliente di entrare in contatto diretto con l'azienda in tempo reale. Un servizio che garantisce interattività, risposte veloci, gestione offerte e un facile accesso alle informazioni sull'ampia gamma di macchine proposte dall'azienda.

In continuo aggiornamento e potenziamento per offrire sempre maggiori opportunità a chi si collega on line, il sito della Griggio si pone come ulteriore strumento offerto al cliente per trovare la risposta giusta, e in tempi rapidi, ad ogni sua richiesta.

Griggio On-Line, en temps réel

Sur Internet pour un service complet et immédiatement accessible.

Le site de la maison Griggio est une porte toujours ouverte qui permet au client d'entrer en contact direct avec la maison en temps réel. Un service qui garantit interactivité, réponses rapides, gestion des offres et un accès facile aux informations sur une vaste gamme de machines proposées par la maison.

La maison a une mise à jour ininterrompue et une grande potentialité pour toujours offrir d'importantes opportunités à qui se branche « on line ». Le site Griggio est un véritable instrument permettant d'offrir au client une réponse exacte et rapides à chaque demande.

Griggio On-Line, en tiempo real

On line para un servicio completo y inmediatamente accesible. El sitio de Griggio es una puerta siempre abierta que permite al cliente entrar en contacto directo con la empresa en tiempo real. Un servicio que garantiza interactividad, contestaciones rápidas, cotización de las ofertas y un fácil acceso a las informaciones de la gama de máquinas propuestas por la empresa.

En continua puesta al día para ofrecer siempre la mejor oportunidad a quien se conecte on line, el sitio de Griggio se pone como un instrumento adicional ofrecido al cliente para buscar la respuesta correcta, y en tiempo rápido, a cada solicitud de información.



www.griggio.com

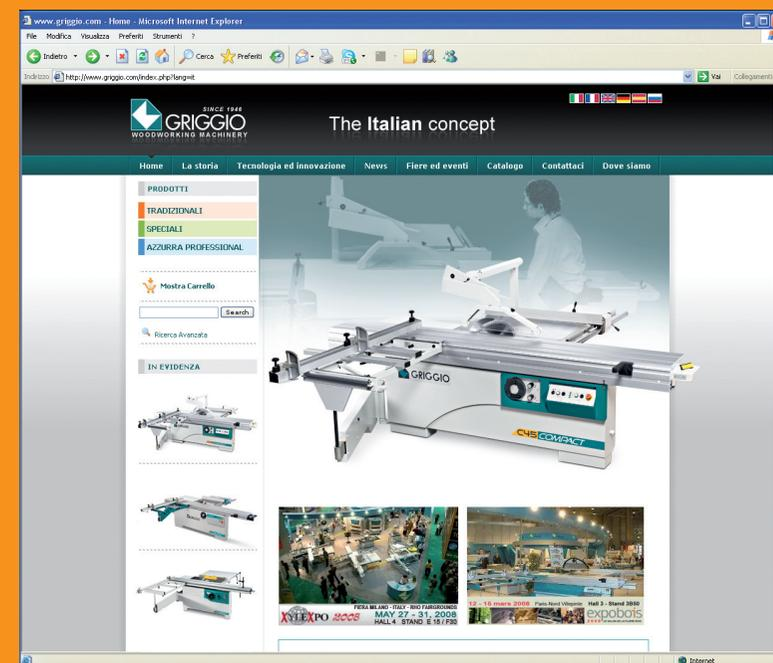

FS41 PLUS

FILO SPESSORE
DEGAUCHISSEUSE - RABOTEUSE
CAPILLADORA - REGRUESADORA

CE

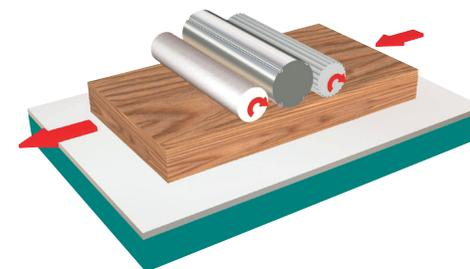



Option
N° 2 rulli sul piano
N° 2 rouleaux sur la table
N° 2 rodillos sobre la mesa



Option
Albero "MONOBLOC" con coltelli Tersa
Arbre "MONOBLOC" avec couteaux Tersa
Eje "MONOBLOC" con cuchillas Tersa



Option
Gruppo cavatrice
Groupe mortaiseuse
Grupo de taladrar

Dimensioni del piano di lavoro a filo <i>Dimensions de la table de travail degau</i> <i>Dimensiones de la mesa de trabajo cepillo</i>	mm	425 x 1900
Piano spessore <i>Table raboteuse</i> <i>Mesa a reguesar</i>	mm	410 x 920
Min/max spessore utile <i>Min/max epaisseur utile</i> <i>Min/max altura a reguesar</i>	mm	9 - 250
Max asportazione filo <i>Maxi prise du bois degau</i> <i>Max asportacion cepillo</i>	mm	5
Ø dell'albero pialla (Coltelli) <i>Arbre dégauchisseuse Ø (Couteaux)</i> <i>Ø del eje (Cuchillas)</i>	mm	100 (n°3)
Velocità di rotazione dell'albero <i>Vitesse de l'arbre</i> <i>Velocidad del eje</i>	g/1' t/1' r/1'	4200
Velocità avanzamento spessore <i>Vitesse d'avancement raboteuse</i> <i>Velocidades de avances</i>	m/1'	8
Motore <i>Moteur</i> <i>Motor</i>	KW (HP) KW (CV) KW (CV)	3,7 (5)

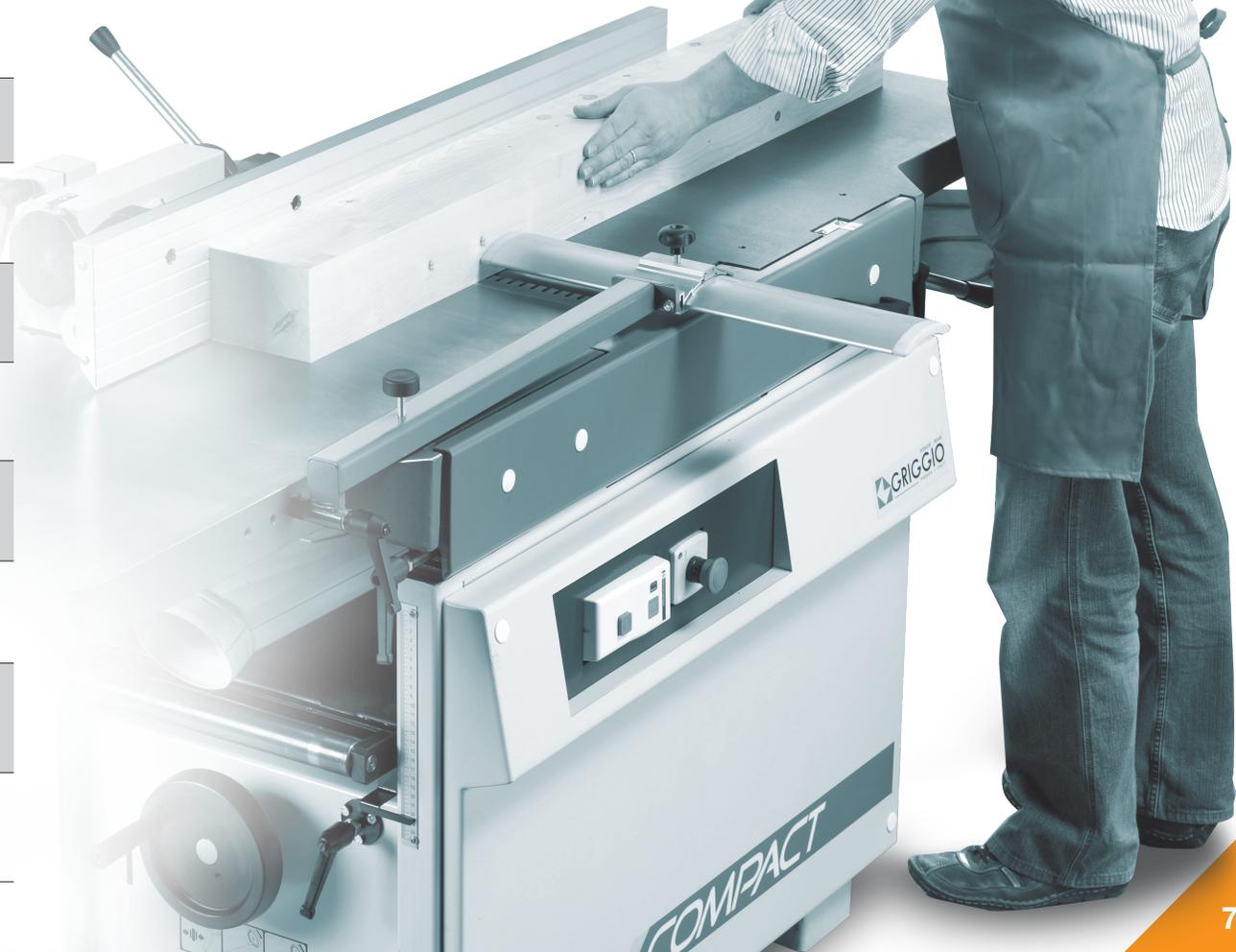



		PS 43	PS 53	PS 63
Dimensioni del piano di lavoro <i>Dimensions de la table de travail</i> <i>Dimensiones de la mesa de trabajo</i>	mm	450 x 900	550 x 900	650 x 900
Spessore utile min.-max. <i>Hauteur à raboter min.-maxi</i> <i>Altura min.-max. a regruesar</i>	mm	3-250	3-250	3-250
Spessore max. di asportazione <i>Prise du bois maxi</i> <i>Espesor util max. de asportacion</i>	mm	6	6	6
Velocità rotazione dell'albero <i>Vitesse de rotation de l'arbre</i> <i>Velocidad de rotacion del eje</i>	g./1' t./1' r/1'	5000	5000	5000
Dia. albero porta coltelli (Coltelli) <i>Dia. arbre porte couteaux (Couteaux)</i> <i>Dia. eje porta cuchillas (Cuchillas)</i>	mm	120 (n°4)	120 (n°4)	120 (n°4)
Velocità di avanzamento <i>Vitesse d'avancement</i> <i>Velocidades de avance</i>	m/1'	5-10	5-10	5-10
Motore <i>Moteur</i> <i>Motor</i>	KW (HP) KW (CV) KW (CV)	4 (5,5)	4 (5,5)	5 (7,5)



La Macchina è completa di:

- Sollevamento automatico del piano (PS 43)
- Sollevamento automatico del piano e visualizzatore meccanico (PS 53)
- Sollevamento automatico del piano, visualizzatore meccanico e 2 rulli sul piano (PS 63)

Machine équipée de:

- Montée automatique de la table (PS 43)
- Montée automatique de la table, affichage mécanique (PS 53)
- Montée automatique de la table et affichage mécanique et 2 rouleaux sur la table (PS 63)

La Maquina es completa de:

- Subida automatico de la mesa (PS 43)
- Subida automatica de la mesa, visualizador mecanico (PS 53)
- Subida automatico de la mesa Y visualizador mecanico y 2 rodillos en la mesa (PS 63)



Option PS 43/53/63
N° 2 rulli sul piano
N° 2 rouleaux sur la table
N° 2 rodillos sobre la mesa



Option
Albero "MONOBLOC" con coltelli Tersa
Arbre "MONOBLOC" avec couteaux Tersa
Eje "MONOBLOC" con cuchillas Tersa

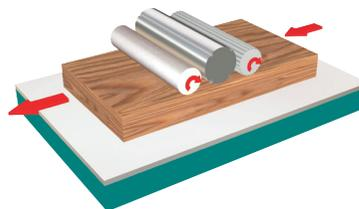

- 1 rullo di traino elicoidale in entrata
- 1 rullo di traino in uscita
- Pressoi registrabili
- Piano senza rulli
- 1 rouleau d'entraînement hélicoïdal en entrée
- 1 rouleau d'entraînement en sortie
- Presseurs enregistrables
- Table sans rouleaux
- 1 rodillo de arrastre helicoidal en entrada
- 1 rodillo de arrastre en salida
- prensos registrables
- mesa sin rodillos

PIALLE A FILO
DEGAUCHISSEUSES / CEPILADORAS

PF 41/53

CE



		PF 41	PF 53
Dimensioni del piano di lavoro <i>Dimensions de la table de travail</i> <i>Dimensiones de la mesa de trabajo</i>	mm	410 x 2600	510 x 2700
Lunghezza piano d'entrata <i>Longeur table d'entree</i> <i>Longitud mesa en entrada</i>	mm	1350	1400
Lunghezza piano d'uscita <i>Longeur table de sortie</i> <i>Longitud mesa en salida</i>	mm	1100	1150
Dimensioni della guida <i>Dimensions du guide</i> <i>Dimensiones de la guía</i>	mm	1350 x 170	1350 x 170
Spessore max. di asportazione <i>Maxi prise du bois</i> <i>Max. profundidad a cepillar</i>	mm	8	8
Velocità di rotazione dell'albero <i>Vitesse de rotation de l'arbre</i> <i>Velocidades del eje</i>	g./1' t./1' r/1'	5000	5000
Dia. dell'albero porta coltelli (Coltelli) <i>Dia. de l'arbre porte-couteaux (Couteaux)</i> <i>Dia. porta cuchillas (Cuhillas)</i>	mm	116 (n°4)	116 (n°4)
Motore <i>Moteur</i> <i>Motor</i>	KW (HP) KW (CV) KW (CV)	3(4)	4(5,5)

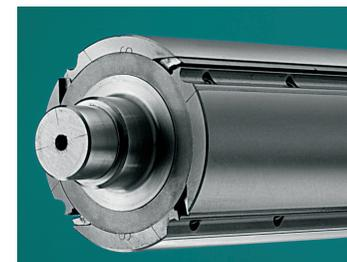

Option
Albero "MONOBLOC" con coltelli Tersa
Arbre "MONOBLOC" avec couteaux Tersa
Eje "MONOBLOC" con cuchillas Tersa



Option
Gruppo cavatrice
Groupe mortaiseuse
Grupo de taladrar

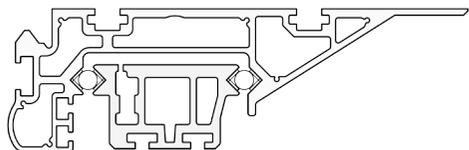

360x2000 mm
360x2600 mm
360x3200 mm



Option



Dimensioni del carro <i>Dimensions du chariot</i> <i>Medidas dl carro</i>	mm	360 x 2000 360 x 2600 360 x 3200
Capacità di squadratura <i>Capacité d'équarissage</i> <i>Capacidad de escuadrar</i>	mm	2000 2600 3200
Lunghezza di taglio fra lama e squadra <i>Largeur de coupe entre lame et guide</i> <i>Ancho de corte entre disco y la escuadra</i>	mm	1050
Ø max lama <i>Ø max lame</i> <i>Ø max disco</i>	mm	315
Ø lama (incisore) <i>Ø lame (inciseur)</i> <i>Ø disco (incisor)</i>	mm	120
Velocità di rotazione dell'albero <i>Vitesse de rotation de l'arbre</i> <i>Velocidades de rotación del eje</i>	<i>g/1'</i> <i>U/1'</i> <i>t/1'</i>	4000
Motore lama <i>Moteur lame</i> <i>Motor disco</i>	<i>Kw (HP)</i> <i>Kw (PS)</i> <i>Kw (CV)</i>	4 (5,5)
Motore incisore <i>Moteur inciseur</i> <i>Motor incisor</i>	<i>KW (HP)</i>	0,5 (1)

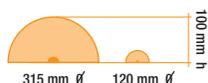

La Macchina è completa di:

- Incisore con motore indipendente KW 0,5
- Carro in alluminio
- Carro e profili anodizzati
- Squadra sul piano con regolazione micrometrica
- Protezione antifortunistica lama
- Pressalegno a vite ed eccentrico

A richiesta:

- Squadra in alluminio inclinabile +30° -45°
- Apertura squadra maggiorata a 1500 mm
- Protezione lama a parallelogramma
- Lame Widia
- Motore monofase

La Machine est équipée de:

- Inciseur avec moteur séparé KW 0,5
- Chariot en aluminium
- Chariot et profiles anodisés
- Guide de la table avec réglage micrométrique
- Protection aux normes de la lame
- Presseur bois à vis et excentrique

Sur demande:

- Guide d'onlet +30° -45°
- Guide parallèle à 1500 mm
- Protecteur lame sur potence
- Lames Widia
- Moteur monophasé

La Máquina está equipada de:

- Incisor con motor independiente KW 0,5
- Carro en aluminio
- Carro y perfiles anodizados
- Escuadra sobre la mesa con regulación micrométrica
- Protección de seguridad del disco
- Prensamadera a tornillo y excéntrico

A pedido:

- Escuadra en aluminio inclinable +30° -45°
- Tope paralelo hasta 1500 mm
- Protección del disco colgado
- Discos en metal duro
- Motor monofásico

SQUADRATRICE CON LAMA INCLINABILE SCIE À FORMAT À LAME INCLINABLE ESCUADRADORA A DISCO INCLINABLE



OPTION
Squadra in alluminio + 30° - 45°
Guide en aluminium + 30° - 45°
Eascuadra en aluminio + 30° - 45°



OPTION



STANDARD
Protezione GOST
Protecteur GOST
Protección GOST



OPTION
Lettore elettronico posizione della guida parallela
Lecteur électronique position de la règle sur la table
Lector electrónico posicionamiento tope paralelo



OPTION

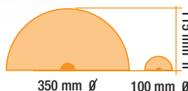

Dimensioni del carro <i>Dimensions du chariot</i> <i>Medidas del carro</i>	mm mm mm	285 x 2600 285 x 3000 285 x 3200
Capacità di squadratura con incisione <i>Capacité d'équarrissage avec inciseur</i> <i>Capacidad de escuadrar con incisor</i>	mm	2700 3080 3260
Larghezza di taglio fra lama e guida parallela <i>Largeur de coupe entre lame et guide parallèle</i> <i>Ancho de corte entre disco y tope paralelo</i>	mm	1050
Ø della lama (a richiesta) <i>Ø de la lame (sur demande)</i> <i>Ø del disco (a pedido)</i>	mm	315(350)* CE 350 BASIC
Altezza di taglio <i>Hauteur de coupe</i> <i>Altura de corte</i>	mm	102 (118)*
Altezza di taglio con lama a 45° <i>Hauteur de coupe avec lame à 45°</i> <i>Altura de corte con disco de a 45°</i>	mm	70 (80)*

Lama inclinabile <i>Lame inclinable</i> <i>Disco inclinable</i>		0 - 45°
Ø dell'albero porta lama <i>Ø de l'arbre porte lame</i> <i>Ø del eje disco</i>	mm	30
Ø lama incisore <i>Ø de la lame inciseur</i> <i>Ø disco incisor</i>	mm	120 (lama 315) 100 (lama 350)
Velocità di rotazione dell'albero <i>Vitesses de rotation de l'arbre</i> <i>Velocidades de rotacion del eje</i>	g/1' t/1' r/1'	4000
Motore <i>Moteur</i> <i>Motor</i>	Kw (HP) Kw (PS) Kw (CV)	4 (5,5)

* Option

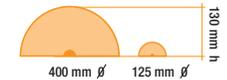

Option

Lettore elettronico posizione della guida parallela
Lecteur électronique position du guide sur la table
Lector electrónico posicionamiento tope paralelo

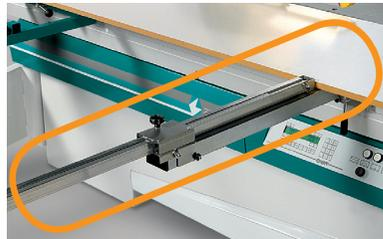

Option

Pianetto tagli paralleli
Tablette pour coupes parallèles
Mesa para cortes paralelos



STANDARD BASIC



STANDARD BASIC
Protezione GOST
Protecteur GOST
Protección GOST



OPTION

Squadra in alluminio + 30° - 45°
Guide en aluminium + 30° - 45°
Escuadra en aluminio + 30° - 45°



OPTION

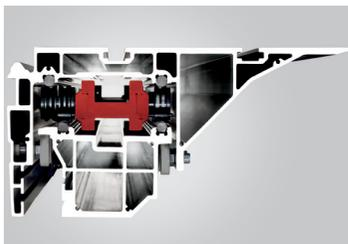

Dimensioni del carro <i>Dimensions du chariot / Medidas del carro</i>		
- CARRO 2600 mm	mm	385 x 2600
- CARRO 3200 mm	mm	385 x 3200
Capacità di squadratura del carro 2600 <i>Capacité d'équarissage du chariot 2600</i> <i>Capacidad de escuadrar carro 2600</i>	mm	2700
Capacità di squadratura del carro 3200 <i>Capacité d'équarissage du chariot 3200</i> <i>Capacidad de escuadrar carro 3200</i>	mm	3260
Ø lama principale <i>Ø lame principale</i> <i>Ø disco principal</i>	mm	400
3 velocità di rotazione <i>3 vitesses de rotation</i> <i>3 velocidades de rotacion</i>	<i>g/1'</i> <i>u/1'</i> <i>rpm</i>	3200 4000 6000
Altezza di taglio a 90° <i>Hauteur de coupe à 90°</i> <i>Altura de corte a 90°</i>	mm	130
Altezza di taglio a 45° <i>Hauteur de coupe à 45°</i> <i>Altura de corte a 45°</i>	mm	90
Inclinazione lama <i>Inclinaison de la lame</i> <i>Inclinacion disco</i>		0° - 45°
Ø lama incisore <i>Ø de la lame inciseur</i> <i>Ø disco incisor</i>	mm	125
Larghezza di taglio tra lama e guida parallela <i>Largeur de coupe entre la lame et le guide parallèle</i> <i>Ancho de corte entre disco y tope paralelo</i>	mm	1250
Potenza motore <i>Puissance moteur</i> <i>Potencia motor</i>	HP (KW)	7,5 (5,5)
US - CSA: Potenza motore <i>Puissance moteur</i> <i>Potencia motor</i>	HP (KW)	9 (6,6)

La Macchina è completa di:

- Gruppo incisore con motore indipendente (con regolazione frontale)
- Carro in alluminio con scorrimento su guide in acciaio a barre di alta precisione
- Carro e profili anodizzati
- Guida estensibile sul carro squadratore con lettura inclinata
- Guida parallela con regolazione micrometrica
- Estensione al piano
- CE: Protezione lama a parallelogramma
- EXP: Protezione di sicurezza
- CE - US - CSA: Avviamento stella-triangolo automatico
- EXP: Avviamento stella-triangolo
- Sollevamento motorizzato della lama
- Inclinazione manuale della lama tramite volantino frontale con indicatore gravitazionale

La máquina es completa de:

- Groupe inciseur avec moteur indépendant (avec réglage antérieur)
- Chariot en aluminium avec glissement sur guides en acier à barres à haute précision
- Chariot et profils anodisés
- Guide extensible sur chariot equarisseur avec lecture inclinée
- Guide parallèle avec réglage micrométrique
- Rallonge à la table
- CE: Protecteur lame sur potence
- EXP: Protecteur de sécurité
- CE - US - CSA: Demarrage étoile-triangle automatique
- EXP: Demarrage étoile-triangle
- Montée motoriste de la lame
- Inclinaison manuelle de la lame par poignée antérieure avec indicateur gravitationnel

A máquina es completa de:

- Grupo incisor con motor independiente (con regulacion en la parte frontal)
- Carro en aluminio con deslizamiento en guías de acero a barras de elevada precisión
- Carro y perfiles anodizados
- Guía extensible aumentada en el carro escuadrador con lectura inclinada
- Tope paralelo con regulacion micrometrica
- Extension de la mesa
- CE: Proteccion disco a paralelogramma
- EXP: Proteccion de seguridad disco
- CE - US - CSA: Arranque estrella-triángulo automatico
- EXP: Arranque estrella-triángulo
- Subida motorizada disco
- Inclinacion manual del disco por volante frontal con indicator gravitacional





CE



T22 BASIC



T22 CE

Dimensioni del piano <i>Dimensions de la table de travail</i> <i>Dimensiones de la mesa de trabajo</i>	mm	1125x670
Corsa verticale albero <i>Course de l'arbre verticale</i> <i>Recorrido vertical eje</i>	mm	150
Diametro max utensile a profilare <i>Diamètre maxi de l'outil à profiler</i> <i>Diaméto max herramienta a perfilar</i>	mm	260
Diametro max utensile a tenonare sopra al piano <i>Diamètre maxi de l'outil à tenonner sur la table</i> <i>Diaméto max herramienta a espigar sobre la mesa</i>	mm	260
Dimensioni max dell'utensile rientrabile sotto il piano di lavoro <i>Dimensions maxi de l'outil escamotable sous la table de travail</i> <i>Dim. max. de la herramienta bajo la mesa de trabajo</i>	(TC) mm	250 x 70 (210 x 70)

Velocità albero <i>Vitesse de l'arbre</i> <i>Velocidad eje</i>	<i>g/1'</i> <i>t/1'</i> <i>r.p.m.</i>	3000-4400-5000 6000-8000-10.000
Potenza motore <i>Puissance moteur</i> <i>Potencia motor</i>	<i>Kw</i> <i>(Hp)</i>	5,5 (7,5)
Ø albero <i>Ø arbre</i> <i>Ø eje</i>	mm	30-35-40-50-1¼
Altezza utile albero Ø 30-35 mm <i>Hauteur utile arbre Ø 30-35 mm</i> <i>Altura util eje Ø 30-35 mm</i>	mm	140
Altezza utile albero Ø 40-50 mm <i>Hauteur utile arbre Ø 40-50 mm</i> <i>Altura util eje Ø 40-50 mm</i>	mm	160



OPTION
Albero intercambiabile MK5
Arbre interchangeable MK5
eje intercambiable MK5



T 22 - TPL



T 22 - TC



OPTION T22-TC



T 22 - TR

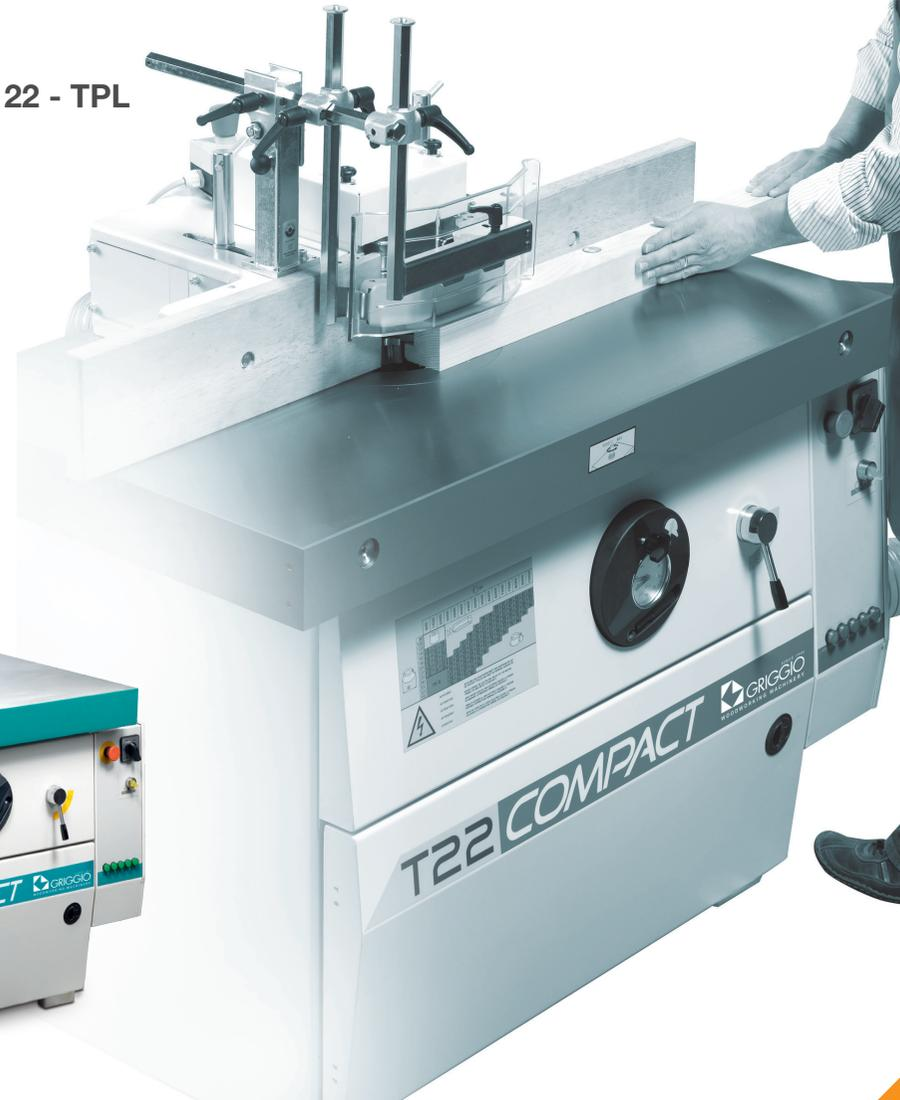

T 45 S

TOUPIE CON ALBERO INCLINABILE +45° -5°
TOUPIE AVEC ARBRE INCLINABLE +45° -5°
TUPI CON EJE INCLINABLE +45° -5°

CE



T 45 S



T 45S - TPL



T 45S - TRG

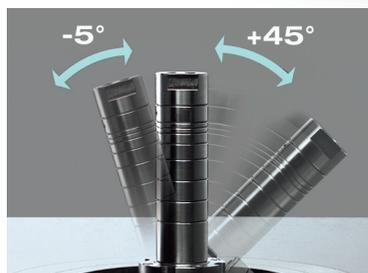

Standard

Dimensioni del piano <i>Dimensions de la table de travail</i> <i>Dimensiones de la mesa de trabajo</i>	mm	1050X750
Ø Albero: lunghezza utile <i>Ø Arbre: hauteur utile</i> <i>Ø Eje: largo util</i>	ø 30 - 35	140
Inclinazione <i>Inclinaison</i> <i>Inclinación</i>		-5° +45°
n° 4 Velocità di rotazione <i>n° 4 Vitesses de rotation</i> <i>n° 4 Velocidades de rotación</i>	g/1' t/1' t/1'	3200 - 4200 6000 - 8000

Ø degli anelli sul piano <i>Ø des bagues sur la table</i> <i>Ø de los anillos sobre la mesa</i>	mm	115 - 170 -220 270 - 345
Ø max utensile a profilare <i>Ø maxi de l'outil à profiler</i> <i>Ø max herramienta a perfilar</i>	mm	260
Ø max utensile a tenonare <i>Ø maxi de l'outil à tenonner</i> <i>Ø max herramienta a espigar</i>	mm	350
Potenza motore <i>Puissance moteur</i> <i>Potencia motor</i>	KW (HP) KW (CV) KW (CV)	4 (5,5)
Carro per tenonare TRG - dimensione del piano <i>Chariot à tenonner TRG - Dimensions de la table de travail</i> <i>Carro a espigar TRG - Dimensiones de la mesa de trabajo</i>	mm	750 x 300

		SN 32	SN 40	SN 50
Ø volani Ø des volants Ø rodillos	mm	320	440	500
Giri volani Rotation des volants Rodillos	g./1' t./1' r/1'	960	900	800
Potenza motore Puissance du Moteur Potencia Motor	KW (HP) KW (CV) KW (CV)	0,56 (0,75)	1,1 (1,5)	1,5 (2)
Altezza max. di taglio Hauteur max. de coupe Altura de corte	mm	160	270	300
Larghezza massima di taglio Largeur max. de coupe Ancho de corte	mm	310	390	480
Dimensioni tavolo da lavoro Dimensions de la table Dimensiones de la mesa	mm	380 - 580	400 x 500	500 x 640
Sviluppo max-min lama Longueur max.-min. de la lame Max.-Min Largo de la sierra	mm	2230 - 2150	3640 - 3560	4130 - 4050



SN 32



SN 40
SN 50

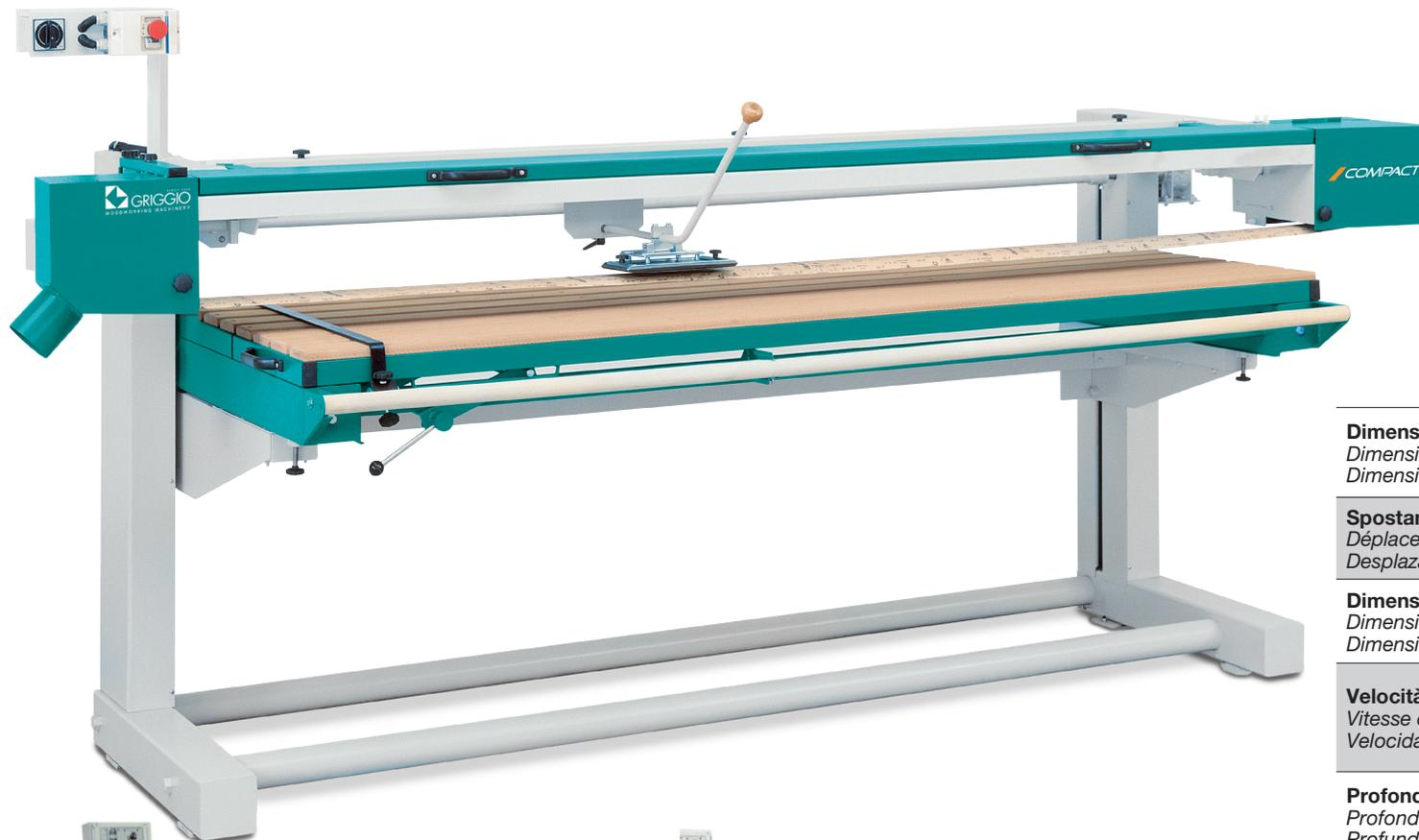

Standard



Option

		L 25	L 30
Dimensioni del piano di lavoro <i>Dimensions de la table de travail</i> <i>Dimensiones mesa de trabajo</i>	mm	2500 x 800	3000 x 800
Spostamento verticale del piano <i>Déplacement vertical de la table</i> <i>Desplazamiento vertical de la mesa</i>	mm	550	550
Dimensioni del nastro abrasivo <i>Dimensions de la bande abrasive</i> <i>Dimensiones de la cinta abrasiva</i>	mm	7000 x 150	7800 x 150
Velocità del nastro <i>Vitesse de la bande</i> <i>Velocidades de la cinta</i>	m/sec mts/sec m/seg	17	17
Profondità utile collo d'oca <i>Profondeur utile du coi de cygne</i> <i>Profundidad útil del doble codo</i>	mm	700	700
Altezza utile collo d'oca <i>Hauteur utile du coi de cygne</i> <i>Altura útil del doble codo</i>	mm	250	250
Ø puleggia <i>Ø de la poulie</i> <i>Ø polea</i>	mm	220	220
Motore principale a 2 velocità <i>Moteur principal à 2 vitesses</i> <i>Motor principal a 2 velocidades</i>	KW (HP) KW (CV) KW (CV)	3 (4)	3 (4)
Potenza motore sollevamento <i>Puissance moteur relevage</i> <i>Potenzia motor subida</i>	Kw	0,37	0,37

AVANZAMENTI AUTOMATICI
 ENTRAÎNEMENTS AUTOMATIQUES
 ALIMENTADORES AUTOMATICOS



GM
 Con cambio manuale
 Avec changement manuel
 Con cambio manual

GA
 Cambio automatico della velocità
 Changement automatique des vitesses
 Con cambio automatico de las velocidades

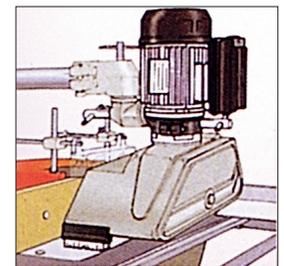
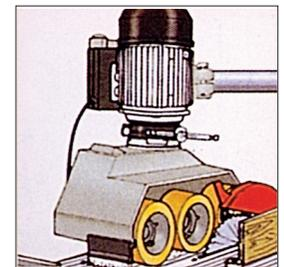
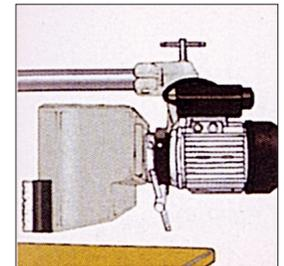
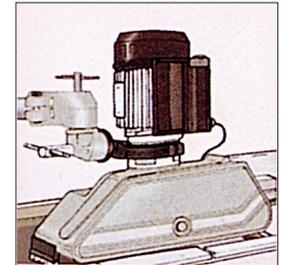

		GM4/34	GA4/38
Rulli Rouleaux Rodillos	n°	3	3
Ø rulli Ø rouleaux Ø rodillos	mm	120 x 60	120 x 60
Velocità di avanzamento con inversione Vitesse d'avan. avec inverseur de marche Velocidad de avance con inversor	m/1'	4-8-11-22	2-4-5-6 11-13-16-33
Potenza motore Puissance du moteur Potencia motor	KW (HP-CV)	0,7/1	0,7/1

		G/A1	G/A2
Numero sacchi Num. sacs Numero sacos	n°	1	2
Ø sacchi Ø sacs Ø sacos	mm	500	500
Capacità sacco Capacité sacs Capacidad saco	L	150	150 x 2
Potenza motore Puissance Moteur Potencia motor	KW(HP)	1,5 KW (2 HP)	2,2 KW (3 HP)
Capacità aspirazione Capacité aspiration Capacidad aspiracion	m³/h	2550	3900
Ø Ventola in acciaio Ø Ventilateur en acier Ø Ventola en acero	mm	300	300



G/A1



G/A2

BORDATRICE MANUALE PLAQUEUSE DE CHANTS MANUELLE CHAPEADORA MANUAL

GB M

CE



Standard



Standard



Standard



Standard

Spessore max pannello <i>Epaisseur maxi panneau</i> <i>Espesor max panel</i>	mm	40
Dimensione Bordo <i>Dimension du bord</i> <i>Medida del canto</i>	mm	0,4 - 3
Velocità avanzamento regolabile <i>Vitesse entrainement réglable</i> <i>Velocidad avance regulable</i>	m/1'	1 - 4
Capacità vasca colla <i>Capacité cuve colle</i> <i>Capacidad calderin</i>	ml	150
Motore Monofase <i>Moteur monophasé</i> <i>motor monofasico</i>	HP	0,25
Controllo elettronico temperatura min./max <i>Contrôle électronique température minimum/maxi</i> <i>Control electronico temperatura min/max</i>		120° - 220°

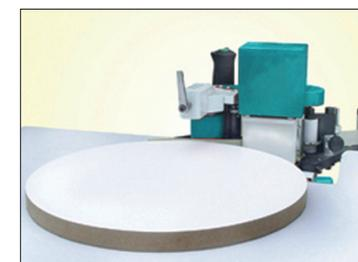
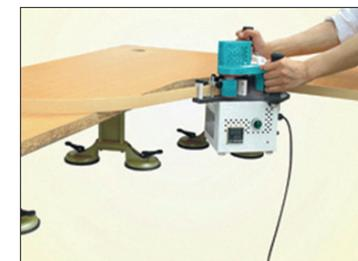
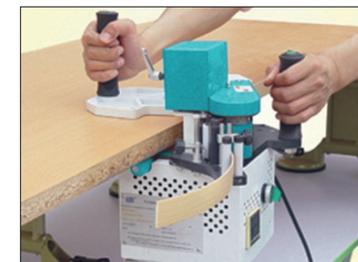

Standard



Standard



Standard

Ingombri e imballi - Encombrement et emballage - Embalaje y anclaje

Mod.		Foto Photo Foto	Peso netto Poids net Peso neto	Peso lordo in cassa Poids brut en caisse Peso bruto en caja de madera	Dimensioni d'ingombro Dimensions d'encombrement Dimensiones de embalaje	Dimensioni d'imballo Dimensions d'emballage Dimensiones de anclaje	Volume Volumen	Ø bocche di aspirazione "CE" Ø bouche d'aspiration "CE" Ø boca de aspiración "CE"	Ø bocche di aspirazione "BASIC" Ø bouche d'aspiration "BASIC" Ø boca de aspiración "BASIC"
			Kg	Kg	mm	mm	m ³	mm	mm
FS 41 PLUS			540	650	1900 x 1200 x 920	2000 x 900 x 1100	2	120	120
PS	43		690	730	950 x 950 x 1250	1000 x 1000 x 1350	1,4	150	150
	53		760	810	1000 x 1000 x 1250	1050 x 1050 x 1350	1,5		
	63		860	920	1100 x 1100 x 1250	1150 x 1150 x 1350	1,8		
PF	41		560	680	2500 x 1120 x 1070	2700 x 750 x 975	2	150	150
	53		620	740	2800 x 1300 x 1070	2900 x 750 x 975	2,1		
SC 30 A			480	590	3100x3500x1200	3200 x 1200 x 1100	4.2	1 x 60 1 x 100	1 x 60 1 x 100
C 30			590	680	3300 x 3500 x 1400	3450 x 1200 x 1100	4,2	1 x 60 1 x 100	1 x 60 1 x 100
C 45			880	990	3300 x 3360 x 910	3400 x 1250 x 1100	4,6	1 x 80 1 x 120	1 x 60 1 x 120
T 22			490	570	1125x670x860	1220x820x1000	1,1	2 x 120	120
TC 22			510	590	1230 x 680 x 860	1220 x 820 x 1000	1,1	2 x 120	120
TPL 22			590	670	2450 x 700 x 860	2650 x 950 x 1000	2,5	2 x 120	120
T 22 TR			640	740	1825 x 1200 x 860	2025 x 1300 x 1000	2,6	2 x 120	120
T 45 S			410	480	1100 x 1300 x 1300	1150 x 1350 x 1100	1,70	2 x 120	120
SN	32		60	80	700 x 480 x 1550	660 x 490 x 1130	0,4	80 120 120	80 120 120
	40		148	198	690 x 560 x 1910	1900 x 520 x 810	0,65		
	50		200	255	870 x 600 x 1970	1990 x 460 x 900	0,8		
L 25			420	480	4000 x 1300 x 1450	1400 x 1050 x 1850 2600 x 1250 x 500	1,8	2 x 100	2 x100
L 30			480	540	4500 x 1300 x 1450	1400 x 1050 x 1850 3100 x 1050 x 1850	1,8	2 x100	2 x 100
GM/GA Crociera di supporto Support a croix Soporte a cruz			40 25	45 30	-	530 x 530 x 330 740 x 300 x 300	0,92 0,73	-	-
G/A1 G/A2			50 60	55 65	930 x 560 x 1950 1500 x 570 x 1950	920 x 580 x 580 1170 x 560 x 570	0,3 0,4	2 x 100 mm 3 x 100 mm	2 x 100 mm 3 x 100 mm
GB M			8,4	30	320 x 300 x 400	470 x 440 x 520	0,1	-	-



MOSCOW

PADOVA



SINCE 1946

GRIGGIO

WOODWORKING MACHINERY



From VENICE	Km 35
From MILAN	Km 245
From ROME	Km 535

COMPACT

GRIGGIO S.p.A.
P.o. Box 54
Via Cà Brion, 40
35011 RESCHIGLIANO (Padova) - ITALY
Tel. (+39) 049 9299711 r.a.
Fax (+39) 049 9201433

e-mail: info@griggio.com
www.griggio.com

GRIGGIO Center
Представительство
Акционерного общества
«ГРИДЖО С.П.А.»
Ул. Флотская, 5 корп. Б, оф 109,
125493, Москва, Россия
Tel. +7-495-544-54-20, fax +7-495-544-54-21
e-mail: info@griggio.ru
www.griggio.ru

